

Common Specifications (applies to all CPF fittings in this datasheet)

DESCRIPTION

CPF♦ is an improved cone type fitting system that adds a unique o-ring sealing system which permits leak free connections without tools. CPF fittings can be directly connected to 1/4" medium pressure cone type fittings from other manufacturers*, provided that wrenches are used to complete the connection. The fittings of the CPF system have been designed and tested to comply with ASME B31.3-2008, Chapter IX: High Pressure Piping.

♦U.S. Patent No. 8,794,677

*HiP: 1/4" Female and Male Medium Pressure (LF4 & LM4 series)

Autoclave Engineers: 1/4" Female and Male Medium Pressure (SF250CX series)

PERFORMANCE

Maximum Allowable Working Pressure (MAWP): **10 000 psi / 700 bar / 70 MPa**
 Finger-tight: **-20 to 50°C**
 Wrench-tight: **-40 to 150°C**
 Minimum Hose Bend Radius: **1.0" (25mm)**

Most fittings throughout this document meet the MAWP specification of 10 000 psi / 700 bar / 70 MPa. Exceptions are labeled with an icon (1, 5, 15) and a key to indicate the pressure rating.

Non-Crystal MP adapters require wrench tightening.

CONSTRUCTION

Thread Type: **7/16-20 UNF 2B**
 Cone Angle: **60°, nominal**
 Fittings: **High Strength 316 Stainless Steel**
 Hose: **Polyamide core with urethane jacket**
 External Hose Diameter: **0.235" (6 mm)**
 Internal Hose Diameter: **0.08" (2 mm)**
 Hose Weight: **0.0179 lbs/ft (26.6 g/m)**
 CPF Female O-rings: **AS568A-012, Viton® 80 or 90 #3981**
 O-ring Lubricant: **Molykote® 55**

Hose is not compatible with dioctyl sebacate fluid.

CAUTION: To achieve CPF maximum allowable working pressures no o-ring substitutions are allowed.

RECOMMENDATIONS

Thread Lubricant: **Use a process compatible fluid**
 Wrench Torque: **100–140 in-lbs (11.3–15.8Nm)**

If a torque wrench isn't practical to use, hand tighten then tighten an additional 20 degrees using a wrench.



Quick Links Click a Category to Navigate to its Page

CPF Fittings	2	Transmitter Fittings	10
NPT Fittings	5	Tube Fitting	10
NPT Fitting Kits	7	AN4 Fittings	11
BSP Fittings	8	Pump Adapter	11
BSP Fitting Kits	8	Non-Crystal MP Adapters	12
M20 Fittings	9		

Note Regarding CPF Hose (MPH-X)

Due to the wide variety of operating conditions it may be subject to, Crystal Engineering, as well as Distributors and Representatives of Crystal products, do not warrant that this hose is suitable for any specific use. This hose is not for use with compressed natural gas (CNG).

When used with gases, fuels (liquid or gas) and refrigerants, permeation (i.e., seepage) will occur from inside the hose. In enclosed or unventilated spaces this permeation may result in high concentrations of vapors which are potentially flammable, explosive or toxic.

Care must be taken to protect hoses from snagging, kinking, bending smaller than the minimum bend radius, and cutting. Any hose that has been damaged in any way should be removed from service and discarded immediately.

Autoclave Engineers Fluid Components is a division of Snap-tite, Inc.

HiP is High Pressure Equipment Company.

Molykote is a registered trademark of Dow Corning Corporation.

Viton is a registered trademark of DuPont Performance Elastomers.

Swagelok is a registered trademark of Swagelok Company.

CPF Fittings

HOSES (10 000 PSI; FOS-4:1)

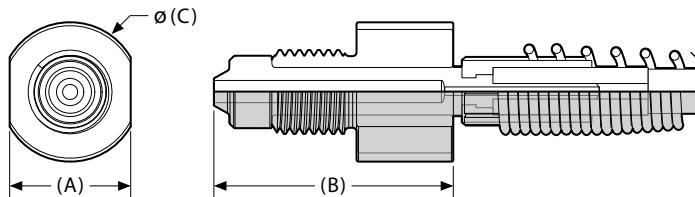

(A)	(B)	(C)
0.63" (16 mm)	1.29" (33 mm)	0.72" (18 mm)

Length	Part Number
1 m	MPH-1
1.5 m	MPH-1.5
3 m	MPH-3
5 m	MPH-5
10 m	MPH-10
25 m	MPH-25
50 m	MPH-50
100 m	MPH-100

MALE CONNECTOR

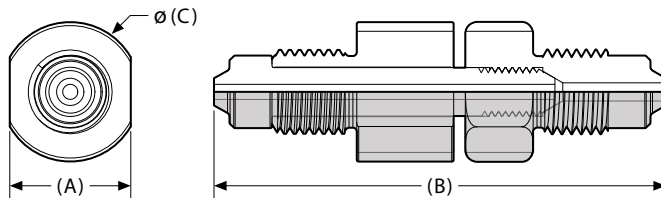

(A)	(B)	(C)	Part Number
0.63" (16 mm)	2.33" (59 mm)	0.72" (18 mm)	MPM-MPM

CPF Fittings

UNION

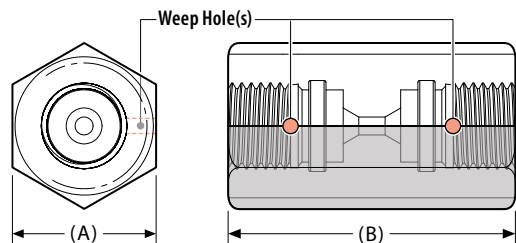

(A)	(B)	Part Number
0.75" (19 mm)	1.50" (38 mm)	MPF-MPF

UNION TEE

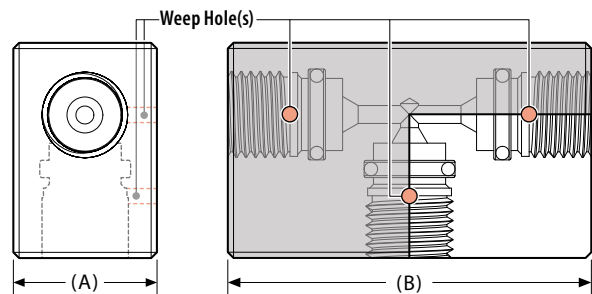

(A)	(B)	Part Number
0.75" (19 mm)	1.90" (48 mm)	MPF-MPFTU

CPF Fittings

BULKHEAD MOUNT

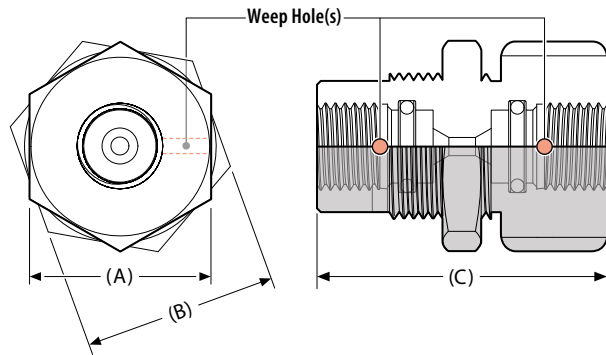

(A)	(B)	(C)	Part Number
0.938" (24 mm)	1.00" (26 mm)	1.50" (38 mm)	MPF-MPFBULK

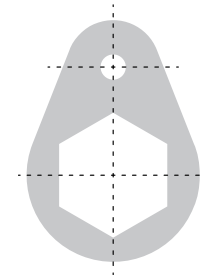

Note:
Includes bulkhead retainer (Part # 4417).

CAP

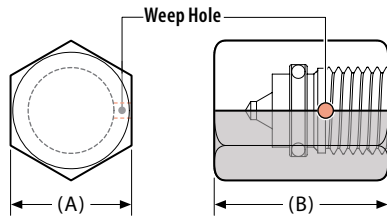

(A)	(B)	Part Number
0.63" (16 mm)	0.90" (23 mm)	MPF-CAP

PLUG

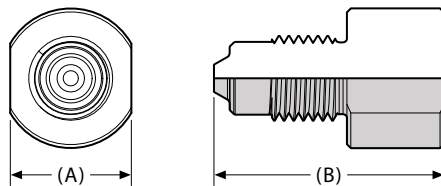

(A)	(B)	Part Number
0.63" (16 mm)	1.19" (30 mm)	MPM-PLUG

NPT Fittings

CPF MALE TO NPT MALE

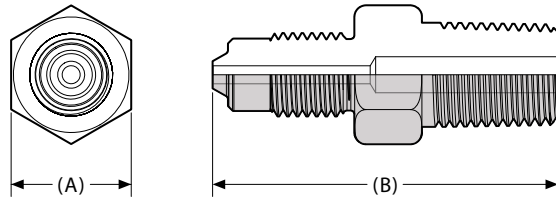

(A)	(B)	Part Number
0.63" (16 mm)	2.50" (64 mm)	MPM-1/8MPT
0.63" (16 mm)	1.80" (46 mm)	MPM-1/4MPT

NPT MALE

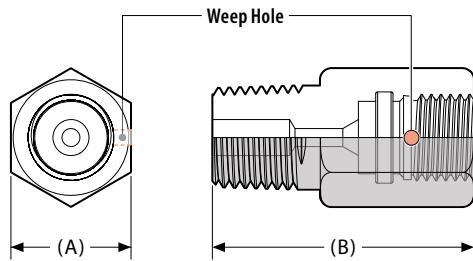

(A)	(B)	Part Number
0.63" (16 mm)	1.12" (28 mm)	MPF-1/8MPT
0.63" (16 mm)	1.36" (35 mm)	MPF-1/4MPT

NPT FEMALE

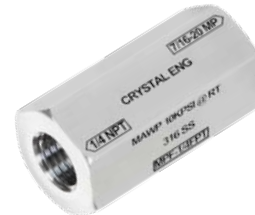
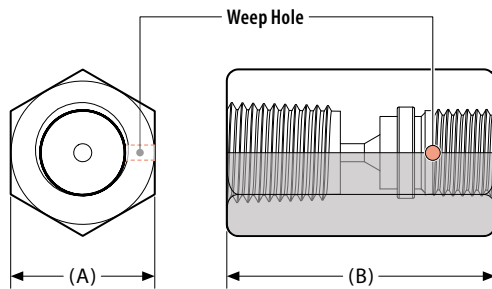

(A)	(B)	Part Number
0.75" (19 mm)	1.40" (36 mm)	MPF-1/4FPT

NPT Fittings

NPT QUICK TEST MALE

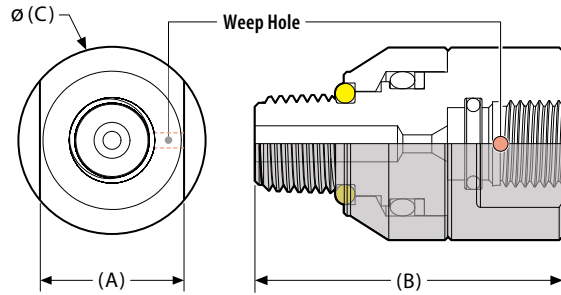

(A)	(B)	(C)	Part Number
0.63" (16 mm)	1.48" (38 mm)	1.00" (25 mm)	MPF-1/8QTM Neoprene 70 Replacement O-ring AS568A-109, #3998
0.75" (19 mm)	1.60" (41 mm)	0.82" (21 mm)	MPF-1/4QTM Neoprene 70 Replacement O-ring AS568A-111, #3996

NPT QUICK TEST FEMALE

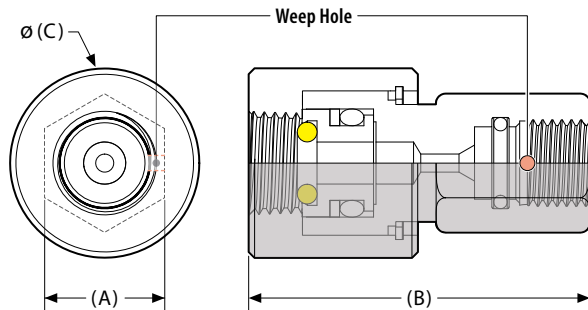

(A)	(B)	(C)	Part Number
0.63" (16 mm)	1.68" (38 mm)	0.85" (22 mm)	MPF-1/8QTF Neoprene 70 Replacement O-ring AS568A-105, #4038
0.63" (16 mm)	1.78" (45 mm)	1.00" (25 mm)	MPF-1/4QTF Neoprene 70 Replacement O-ring AS568A-108, #4007
0.63" (16 mm)	1.81" (46 mm)	1.37" (35 mm)	MPF-1/2QTF Neoprene 70 Replacement O-ring AS568A-112, #4042

Fitting rated to 5000 psi ⁵

90° NPT MALE

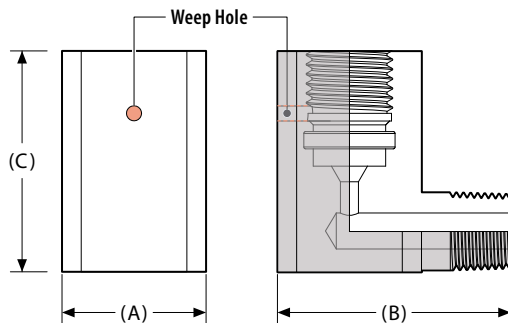

(A)	(B)	(C)	Part Number
0.75" (19 mm)	1.20" (31 mm)	1.15" (29 mm)	MPF-1/8MPT90

NPT Fittings

NPT MALE TO NPT QUICK TEST FEMALE

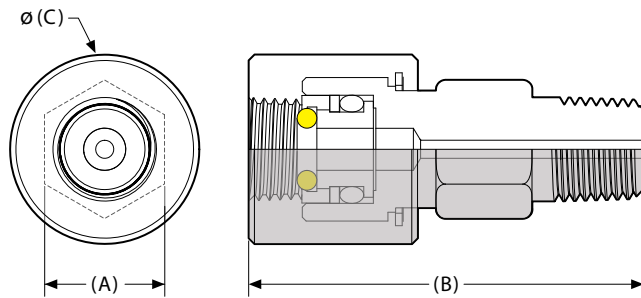

(A)	(B)	(C)	Part Number
0.63" (16 mm)	1.90" (48 mm)	1.00" (25 mm)	1/8MPT-1/4QTF Neoprene 70 Replacement O-ring AS568A-108, #4007
0.63" (16 mm)	2.06" (52 mm)	1.00" (25 mm)	1/4MPT-1/4QTF Neoprene 70 Replacement O-ring AS568A-108, #4007

NPT FITTING KITS



		Part Number
Complete NPT Hose and Fitting Kit	Includes: 1/8 NPT [Male (2), Male 90°, Male Quick Test, and Female Quick Test], 1/4 NPT [Male (2), Female, Male Quick Test, and Female Quick Test], 1/2 NPT [Female Quick Test], Tube [1/4 Male, 3/8 Male, and 1/2 Male], AN4 Male, Transmitter [1/4 Male and 5/16 Male], CPF Connectors [Male-Male, T-Union, Plug, and Cap (2)], Hose [1 meter], and Custom Carrying Case.	4016
Quick Test NPT Kit	Includes: MPF-1/8QTF, MPF-1/4QTF, and MPF-1/2QTF	4013

BSP Fittings

CPF MALE TO BSP MALE

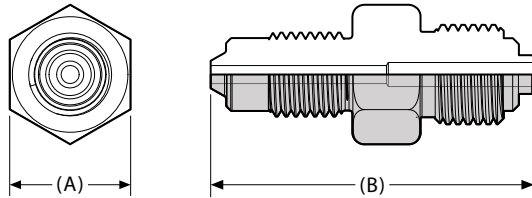

(A)	(B)	Part Number
0.63" (16 mm)	1.68" (43 mm)	MPM-1/4BSPM

BSP FEMALE

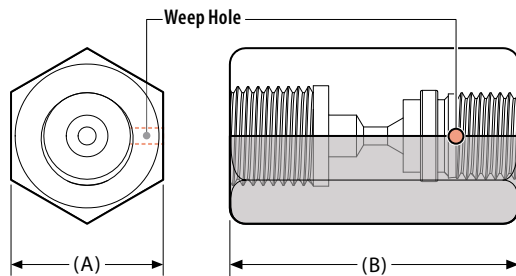

(A)	(B)	Part Number
0.79" (20 mm)	1.50" (38 mm)	MPF-1/8BSPF
0.79" (20 mm)	1.50" (38 mm)	MPF-1/4BSPF
0.98" (25 mm)	1.75" (45 mm)	MPF-3/8BSPF
1.18" (30 mm)	2.05" (52 mm)	MPF-1/2BSPF

BSP FITTING KITS



		Part Number
Complete BSP Hose and Fitting Kit	Includes: BSP Female [1/8, 1/4 (2), 3/8, and 1/2], NPT [1/4 Quick Test Female and 1/8 Male (2)], Transmitter [1/4 Male and 5/16 Male], CPF Connectors [Male-Male, T-Union, Plug, and Cap (2)], Hose [1 meter], Custom Carrying Case.	4017
BSP Test Kit	Includes: MPF-1/8BSPF, MPF-1/4BSPF, MPF-3/8BSPF, and MPF-1/2BSPF	4015

M20 Fittings

CPF MALE TO M20 MALE

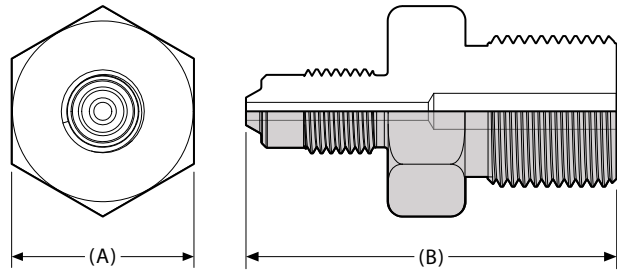

(A)	(B)	Part Number
0.95" (24 mm)	1.93" (49 mm)	MPM-M20X1.5M

M20 FEMALE

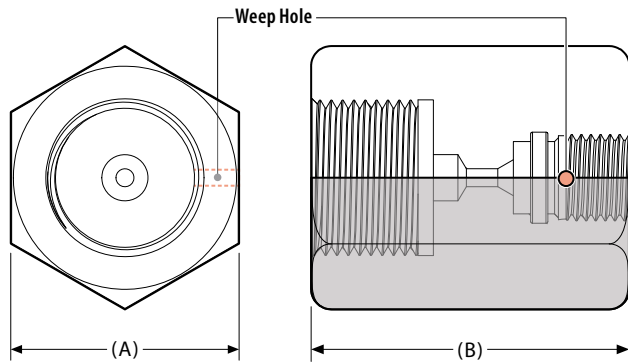

(A)	(B)	Part Number
1.18" (30 mm)	1.65" (42 mm)	MPF-M20X1.5F

M20 QUICK TEST FEMALE

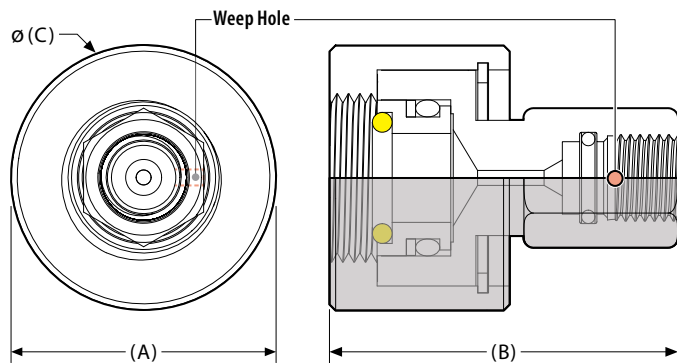

Swivels

(A)	(B)	(C)	Part Number
0.63" (16 mm)	1.81" (46 mm)	1.375" (35 mm)	MPF-M20QTF
			Neoprene 70 Replacement O-ring AS568A-112, #4042

Fitting rated to 5000 psi

Transmitter Fittings

FOR FOXBORO, ROSEMOUNT, & YOKOGAWA

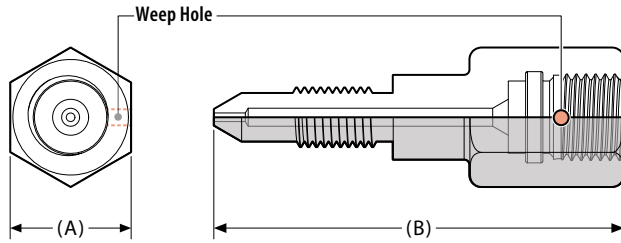

(A)	(B)	Part Number
0.63" (16 mm)	2.13" (54 mm)	MPF-5/16TRM

FOR HONEYWELL

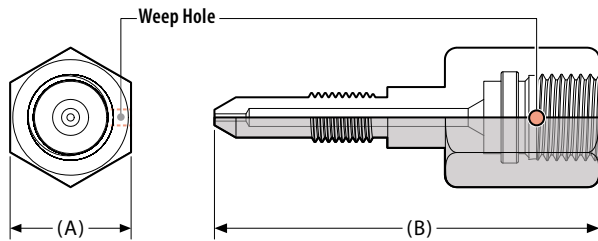

(A)	(B)	Part Number
1.18" (30 mm)	1.65" (42 mm)	MPF-1/4TRM

Tube Fitting

TUBE MALE

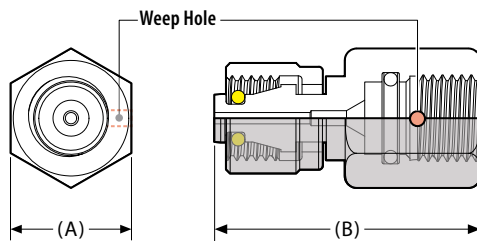

(A)	(B)	Part Number
0.63" (16 mm)	1.38" (35 mm)	MPF-1/4TBM
	VITON 90 Replacement O-ring	AS568A-007, #4104
0.63" (16 mm)	1.50" (38 mm)	MPF-3/8TBM
	VITON 90 Replacement O-ring	AS568A-010, #4051
0.63" (16 mm)	1.74" (44 mm)	MPF-1/2TBM
	VITON 80 Replacement O-ring	AS568A-012, #3981

Fittings rated to 5000 psi

AN4 Fittings

AN4 MALE

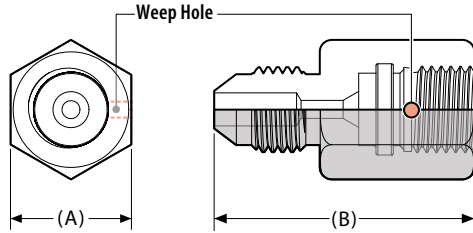

(A)	(B)	Part Number
0.63" (16 mm)	1.35" (34 mm)	MPF-AN4M

AN4 UNION SWIVEL (NON CRYSTAL)

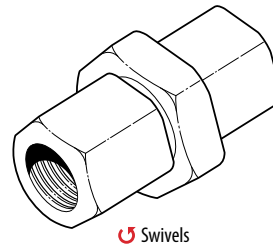
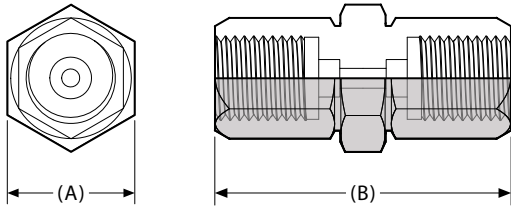

(A)	(B)	(C)	Part Number
0.56" (14 mm)	1.60" (41 mm)	0.69" (17 mm)	4377

Fittings rated to 5000 psi

Pump Adapter

QUICK CONNECT NUT

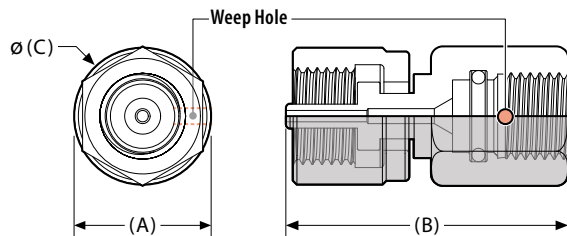

(A)	(B)	Part Number
0.63" (16 mm)	1.47" (37 mm)	MPF-QCN

Fittings rated to 5000 PSI

Non-Crystal MP Adapters

MEDIUM PRESSURE MALE TO NPT FEMALE

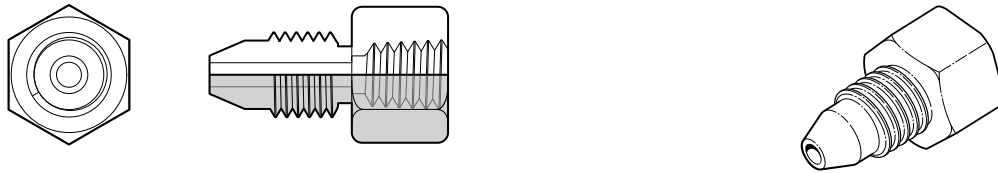

Size	Product Marking	Part Number	
1/8 NPT	2NF04M15	4497	15
1/4 NPT	4NF04M15	4498	15
3/8 NPT	6NF04M15	4499	15
1/2 NPT	8NF04M15	4500	15

MEDIUM PRESSURE MALE TO NPT MALE

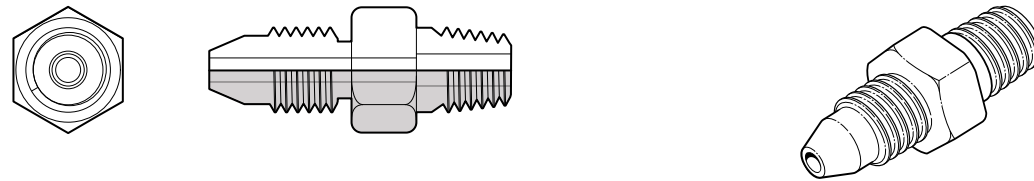

Size	Product Marking	Part Number	
1/4 NPT	4N04M15	4698	15
3/8 NPT	6N04M15	4492	15
1/2 NPT	8N04M15	4493	15

MEDIUM PRESSURE FEMALE TO NPT FEMALE

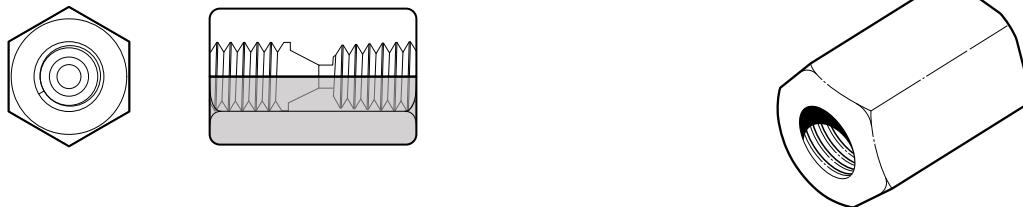

Size	Product Marking	Part Number	
1/8 NPT	2NF04MF15	4501	15
1/4 NPT	4NF04MF15	4715	15
3/8 NPT	6NF04MF15	4502	15
1/2 NPT	8NF04MF15	4503	15

MEDIUM PRESSURE FEMALE TO NPT MALE

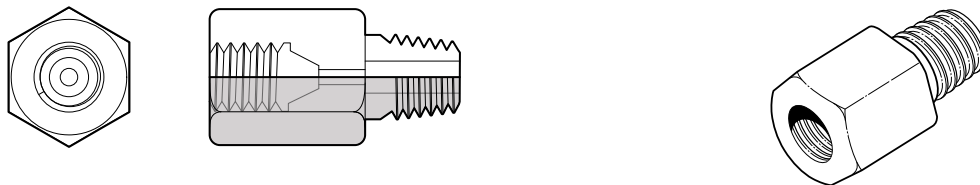

Size	Product Marking	Part Number	
1/4 NPT	4N04MF15	4714	15
3/8 NPT	6N04MF15	4494	15
1/2 NPT	8N04MF15	4495	15
3/4 NPT	12N04MF10	4496	

Fittings rated to 15000 PSI 15

Non-Crystal MP adapters require wrench tightening.